



UNIVERSAL TRUCK BED RACK USER MANUAL

Please read this manual carefully before installation, and retain it for future reference.

V1.0

WARNINGS AND SAFETY INSTRUCTIONS

GENERAL GUIDELINE

- The user must ensure that all accessories are properly secured to the rack before driving. It is crucial that you do not load the rack beyond the safe capacity of your vehicle. Refer to your vehicle's owner's manual for load ratings and installation recommendations for this product.
- The static load rating of this product is 1,100 lbs, and the dynamic rating is 660 lbs (evenly distributed). It is important to distribute weight evenly and avoid sudden load movements, which may create excess load and lead to product failure. A "distributed load" refers to a load that is spread out and not concentrated in a small area.
- Modifying or using this product for unintended purposes voids the warranty and may result in hazardous conditions that can cause property damage, serious bodily injury, and even death.
- This rack is intended solely for transporting recovery tracks, fuel tanks, water tanks, tents, farm jacks, awning tents, spare tires, and similar items that are safe to transport.
- Ensure that all adjustable parts are properly positioned for maximum support. Improper installation may reduce the capacity and stability of the product.
- Regularly inspect the rack for signs of damage or wear to ensure a high level of safety. If you notice any visible damage to any part of the rack, do not use it.

INSTALLATION SAFETY

- It is essential to follow the instructions carefully when installing the product. Improper installation can create hazardous conditions.
- Before beginning installation, park your truck on a flat, level, hard surface away from traffic. Shift the vehicle to park or neutral gear and engage the parking brake.
- Before drilling or driving screws, ensure that the installation surface is free of any hidden wires. Wear safety goggles and work gloves during assembly and installation.
- Maintain a clean and well-lit installation area, and keep bystanders away during installation.
- Do not attempt to install the product when you are tired or under the influence of drugs or medication.

DRIVING SAFETY

- Always exercise caution when driving with accessories mounted on the bed rack. The added weight can alter the driving dynamics of your vehicle.
- Take note of the total vehicle height and width with the bed rack and accessories mounted, and ensure safe passage under any low clearances.
- Before loading cargo or operating your truck, verify that the bed rack and accessories are mounted securely.
- Carrying a load above the rack will increase the center of gravity of your truck, significantly affecting its ability to maneuver, turn, stop or accelerate. Avoid sharp turns and excessive speeds as these actions can increase the risks.
- When transporting wind-resistant loads, exercise extreme care for safety reasons. Special consideration should be taken when cornering and braking. Note for dealers and installers: It is your responsibility to provide instructions to the end-user or client.
- Check bolt connections at regular intervals to ensure their tightness.









LOADING SAFETY

- It is essential to tie down all loads securely to the rack to prevent them from vibrating, sliding, or being blown off by unexpected wind or road hazards.
- To avoid roll-over, ensure that loads are not top-heavy and transport high loads with extreme caution to prevent striking low overhead objects or tipping during turns, abrupt stops, or high winds.
- Keep the center of gravity as low as possible to maintain stability.
- Regularly check secured loads and connections for tightness to prevent damage and alteration of the vehicle's handling and braking characteristics or rollover.
- Follow local regulations and laws to secure loads according to height and identification requirements.
- Failure to secure cargo or hauling inappropriate cargo may result in severe injury or death.

INSPECTION AND MAINTENANCE

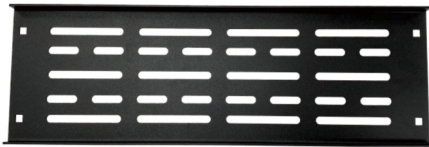
- Regularly inspect all components for signs of wear or damage. Check for loose bolts and parts, and tighten as necessary.
- Replace any parts that are damaged or worn. It's important to perform inspections and maintenance as soon as any malfunctions are observed or suspected.

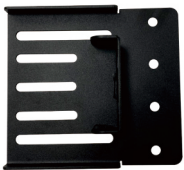
INCLUDED PARTS & HARDWARE

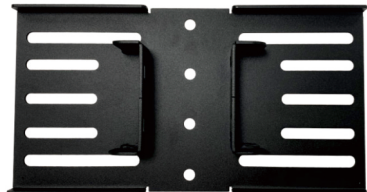
1 PC(s) Front Cross Beam			
2 PC(s) Rear / Middle Cross Beams		6 PC(s) Lower Legs	
2 PC(s) Top Rails		4 PC(s) Accessory Panels	
4 PC(s) Top Connecting Beams		4 PC(s) Connecting Plates (Side)	
6 PC(s) Upper Legs		2 PC(s) Connecting Plates (Middle)	

154 PC(s) M8*20 Screws	18 PC(s) M10 Washers
154 PC(s) M8 Nylock Nuts	18 PC(s) M10 Spring Washers
154 PC(s) M8 Washers	18 PC(s) M10 Nylock Nuts
154 PC(s) M8 Spring Washers	6 PC(s) M10*30 Screws
1 PC(s) User Manual	12 PC(s) M10*50 Screws

ASSEMBLY

It is advisable to construct the basic structure on a level surface prior to mounting it on your truck. This approach enables you to facilitate installation at a lower height and subsequently make modifications to suit your specific needs.

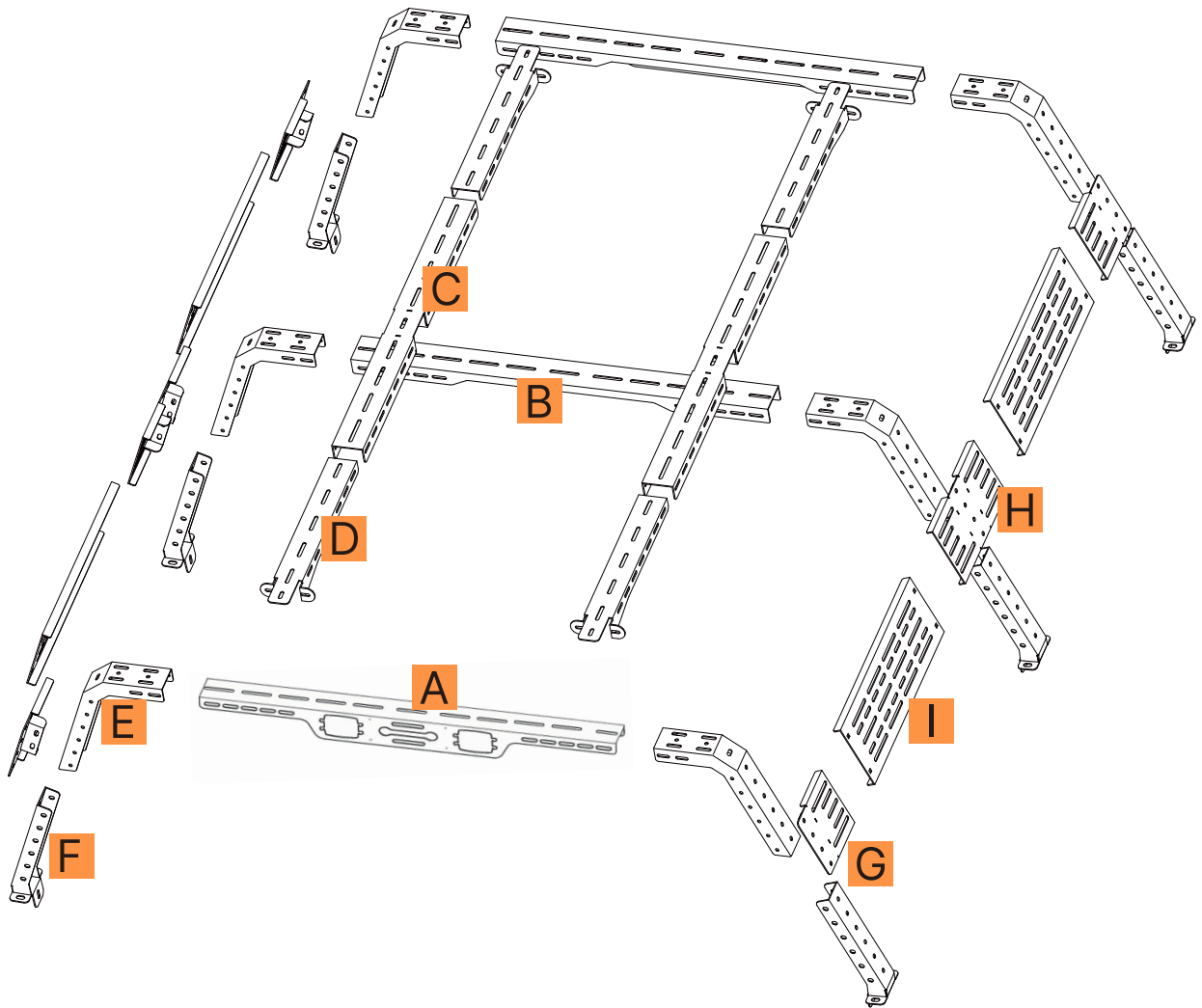

- A:** Front Cross Beam
- B:** Rear/Middle Cross Beams
- C:** Top Rails
- D:** Top Connecting Beams
- E:** Upper Legs
- F:** Lower Legs
- G:** Connecting Plates (Side)
- H:** Connecting Plates (Middle)
- I:** Accessory Panels

1. PREPARATION

Upon opening the box, arrange all parts neatly. Additionally, ensure that you have the following tools on hand:

- Spanner
- Drill Bit
- Allen Key
- Drill
- Tape
- Tape Measure
- Marker Pen
- Deburring Tool
- Center Punch
- Touch Up Paint

2. ASSEMBLE THE BED RACK

Step 1 : Assemble the Front Assembly

Adjust the rack to match your truck bed's width. Use M8*20 screws to install the front cross beam (A) onto the upper legs (E). Ensure the screw head faces outward with a spring washer and a flat washer on the outside, and nut on the inside. Do not fully tighten yet, as adjustments may be needed. Repeat the same steps for the middle and rear assemblies.

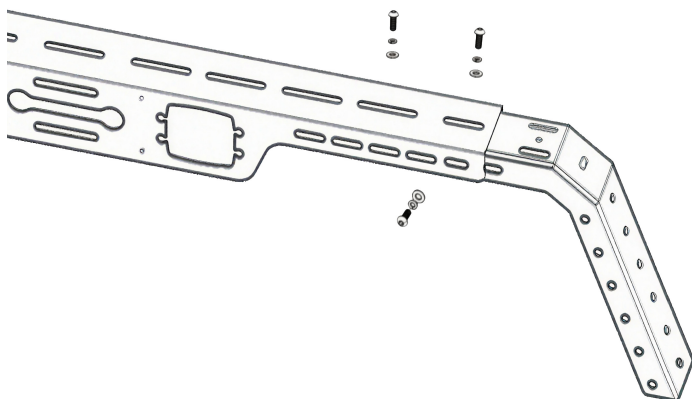

STEP 2. Attach the Top Rails

Attach the two top rails (C) to the top of the rack, connecting them with the top connecting beams (D). Secure with bolts, spring washers, washers, and nuts. The rack will now stand freely.

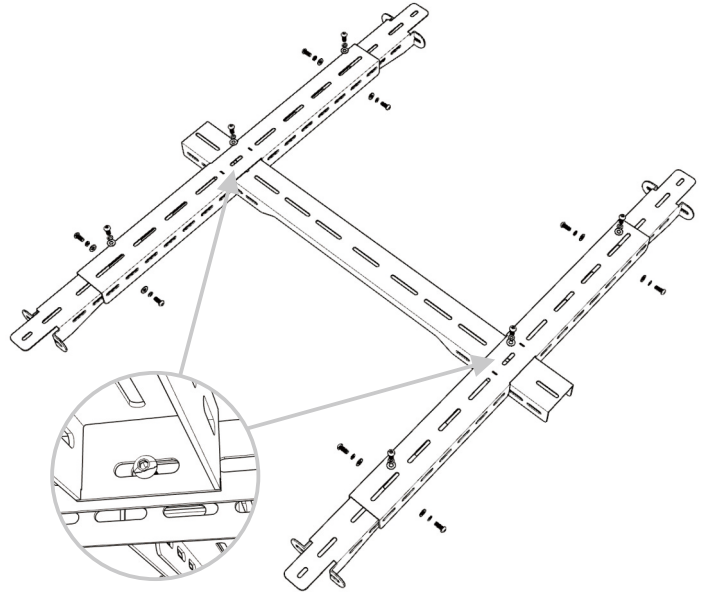

STEP 3: Attach the Connecting Plates (side) & Lower Legs

Install the side connecting plates (G) to the assemblies. Secure with bolts, spring washers, washers, and nuts along with the lower legs (F).

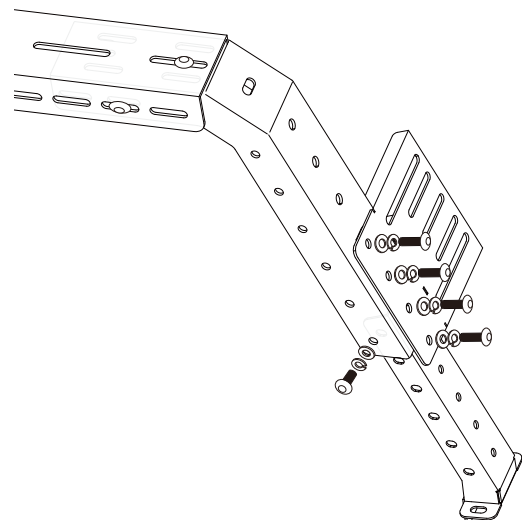

Step 4: Attach the Connecting Plates (Middle) and Accessory Panels

Attach the middle connecting plates (H) and accessory panel (I) to the rack. Secure the middle connecting plates with screws, spring washers, and washers. No spring washers are required for the accessory panels (refer to the image below).

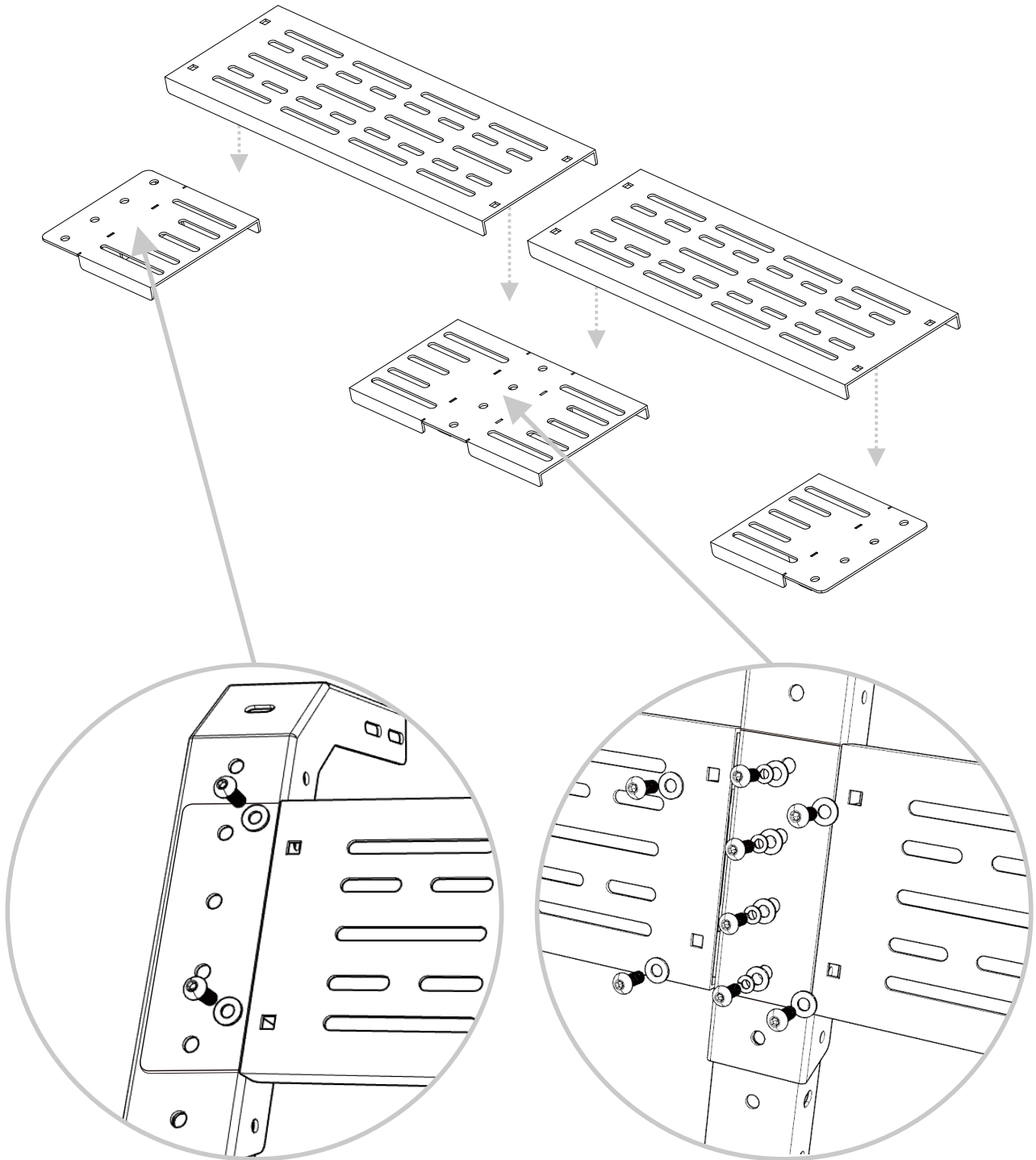

STEP 5: Grab a buddy to place the rack on top of the truck bed in the desired position. Use a marker to mark the centre of the mounting holes of the lower legs (F). These are the drill holes for your rack.

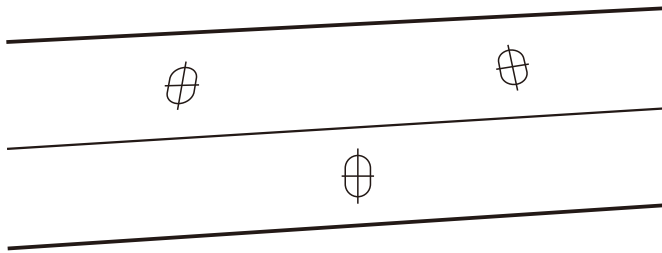

STEP 6: Once all holes are marked, remove the rack. Drill pilot holes on the previous marked positions. Then widen the holes.

STEP 7: Use a deburring tool to clean up the drilled holes and touch up the paint to prevent rust on the freshly drilled metal.

STEP 8 : Once the paint is dry, the rack can be re-mounted. Attach M10*50 screws to the vertical holes drilled and M10*30 screws to the horizontal holes drilled into the tub. Tighten all bolts, nuts, spring washers, and washers securely on each leg of the rack.

STEP 9 : Make sure to tighten all screws washers, spring washers and nylock nuts properly to complete the installation.

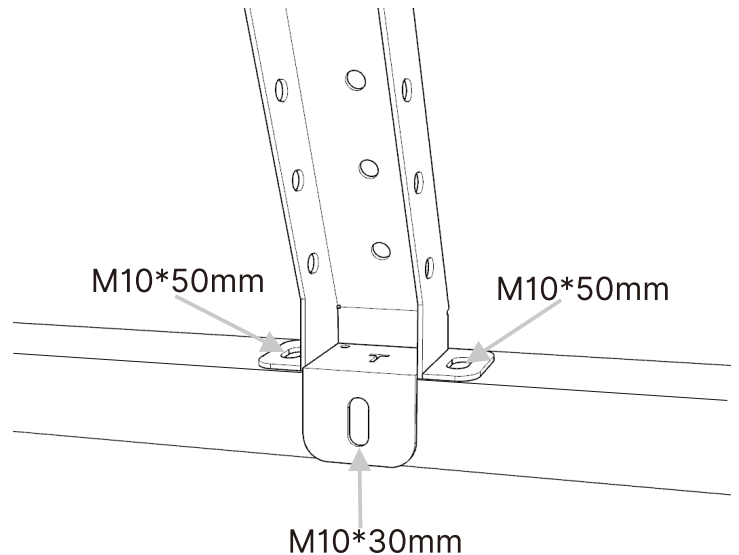

WARRANTY

Manufacturer warrants to the original purchaser ("User") that its truck bed rack, if purchased from the manufacturer or an authorized distributor or dealer, will be free from defects in material and workmanship under normal usage from the date of sale and for a duration of one year (the "Warranty Period").

This warranty is only effective for the original purchaser and applies solely to the manufacturer bed rack that is correctly installed on the vehicle. Manufacturer will either replace the product or provide a refund at its discretion provided that the fault is found to have been caused by a design or manufacturing defect that results in its failure to perform correctly as described. This limited warranty is the only warranty that applies to this product, and it sets forth all the responsibilities of manufacturer. No labor or service allowance is given or implied. Manufacturer shall not be liable for incidental, consequential, or special damages or charges under any circumstances.

EXCLUSIONS:

This warranty does not cover defects, failures, or damages caused by incorrect installation or intentional damage. To avoid voiding the warranty, it is recommended that the installation should be performed by suitably qualified technicians. This warranty is also void if the bed rack is:

- damaged by extreme weather, normal wear and tear, alteration, or failure to check the condition of the rack before and during every journey,
- damaged by abuse, neglect, misuse, or as a result of an accident or any other cause,
- misapplied, overloaded, or improperly installed.